

Data Sheet



Article number: 20073510

Description: E+G Ball joints
GN 782-M8-KI-2

Measures

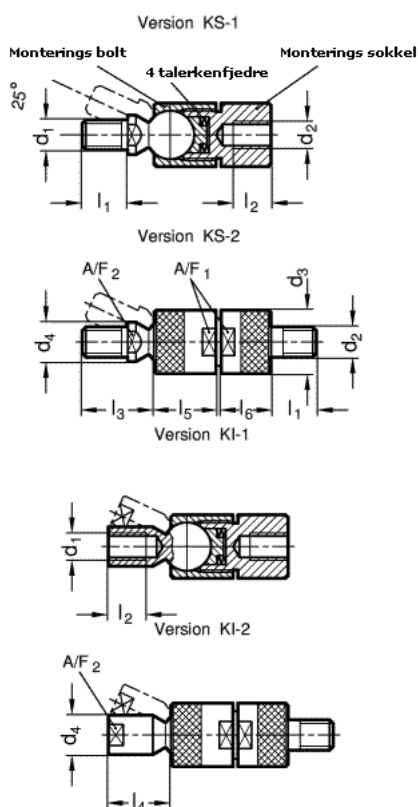

d1 = M 8	l5 = 18.5
d2 = M 8	l6 = 15
d3 = 19	sw1 = 17
d4 = 11	sw2 = 9
l1 = 12	
l2 = 10	
l3 = 19.5	
l4 = 18.0	